

2900 serie

profiel

2900
215 gr/m

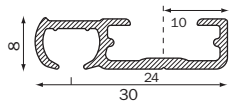

2901
274 gr/m

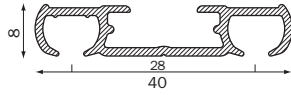

2904
488 gr/m

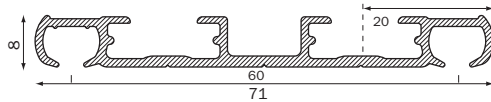

2905
732 gr/m

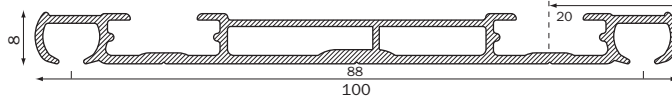

2906
741 gr/m

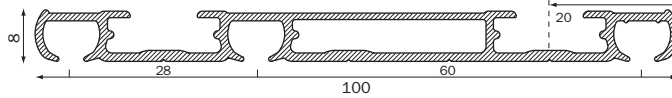

buigen

radius cm
R 15 (1015)
R 20 (1015)
R >150 (1018)

strip plaatsing

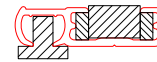

R 20 (1015)
R 25 (1015)
R >150 (1018)

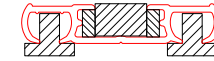

Montage

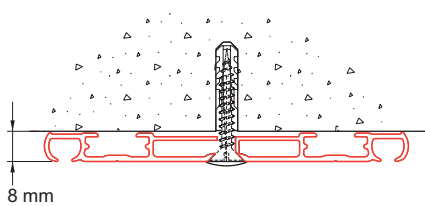

Plafondmontage voorgeboorde 2905 met 2914-WD schroef met wit afdekdopje

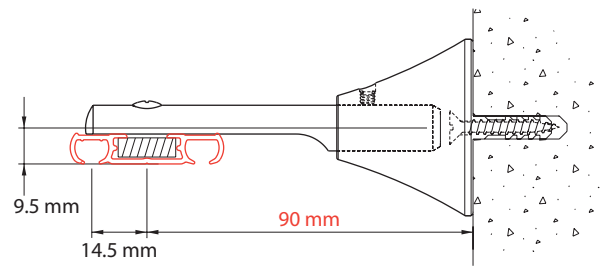

Wandmontage 2901 met afstandsteun 2917-09

	2917-15	2917-09
2900	150	90
2901	150	90

Toepassingsvoorbeeld

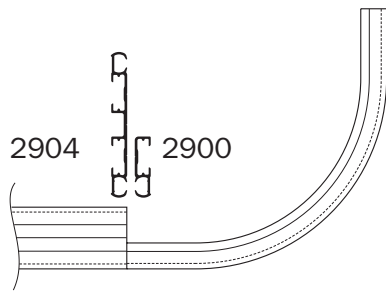

combinatie van het brede profiel 2904 met 90 graden retour 2900-R-W, gekoppeld via railverbinder 2952.

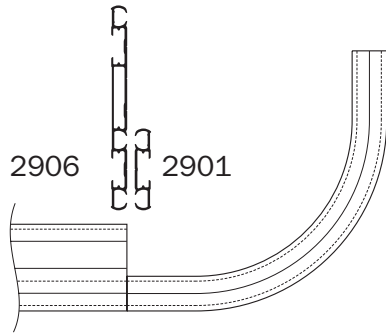

combinatie van brede profielen als 2905, 2906 met 90 graden retour 2901-R-W, 2 kanalen, gekoppeld via railverbinder 2952.

G-Norm

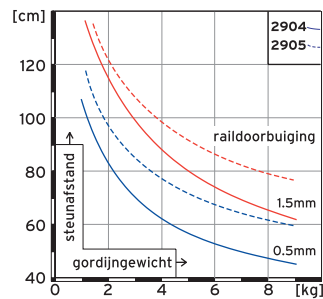
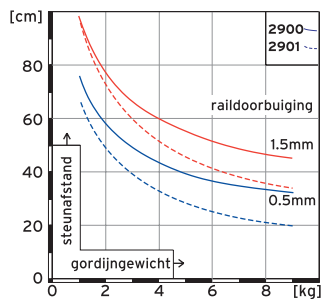

Steunafstand volgens de G-norm of onderstaande tabel.

	licht	middel	zwaar	(gordijn)
2900	80	60	50	
2901	70	50	40	
2904	110	90	70	
2905	120	100	80	
2906	120	100	80	

Toepassingsvoorbeeld

Standaard verdeling van glijders en eindstops over de 2900-serie kanalen, bijvoorbeeld om overlap te creëren bij meerkanaals profielen. Gemiddelde boorgat-afstanden weergegeven.

