

# 5600

## profiel

**5600**  
492 gr/m

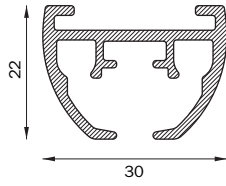

## buigen

radius cm  
R 20 (1015)  
R 30 (1015)  
R >100 (1018)

## strip plaatsing

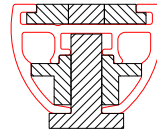

## Montage

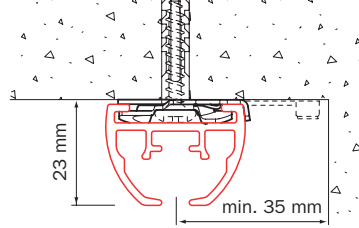

plafondmontage met spanner 6050

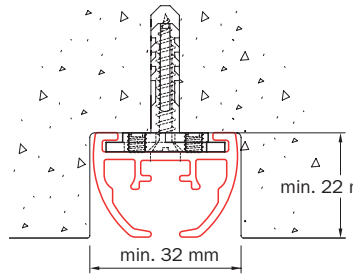

blindmontage b.v. in groef met steun 6055-2000 bij bochten: freesgroef maken op basis van geleverde rail

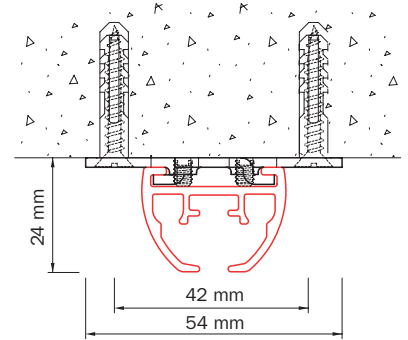

plafondmontage met plafondsteun 6055-1000

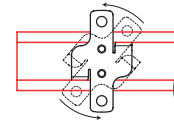

montage: draaien & borgen

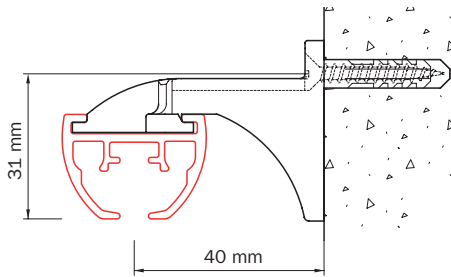

wandmontage met wandsteun 6051

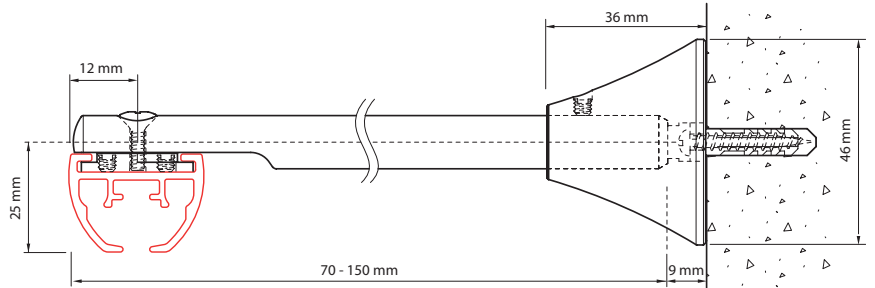

wandmontage met inkortbare afstandsteun 6017

## G-norm

### 5600

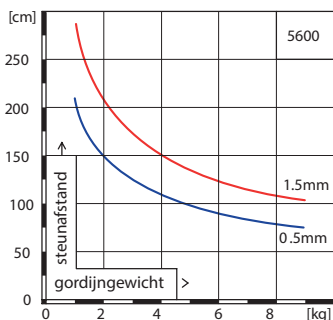

## Exploded view

### 5600

